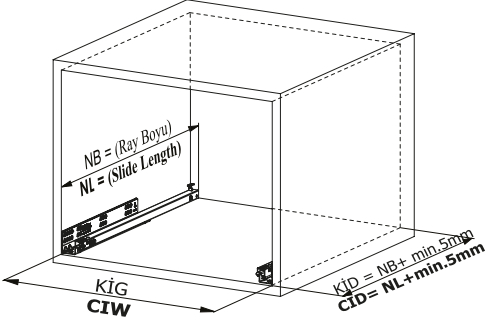
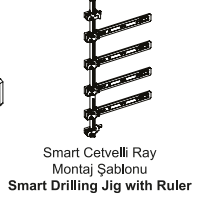
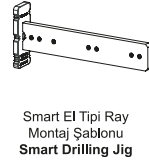
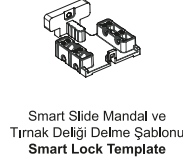
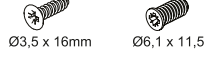
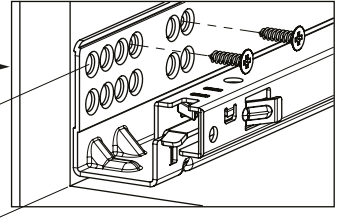
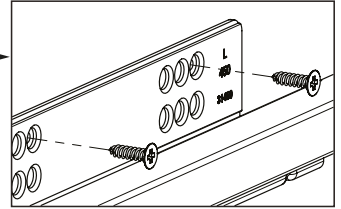
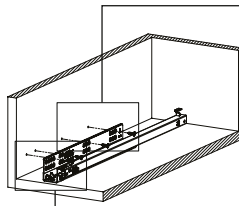
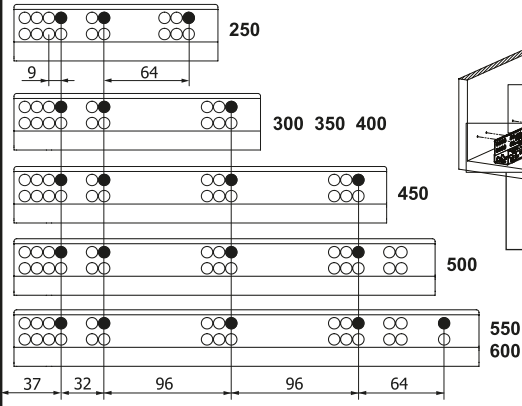
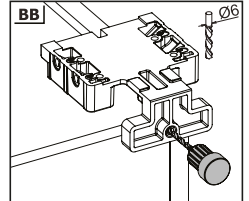
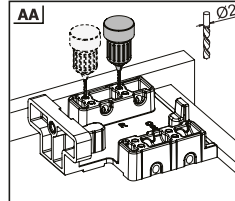
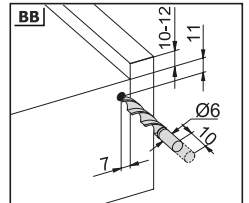
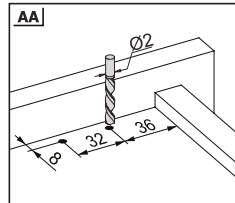
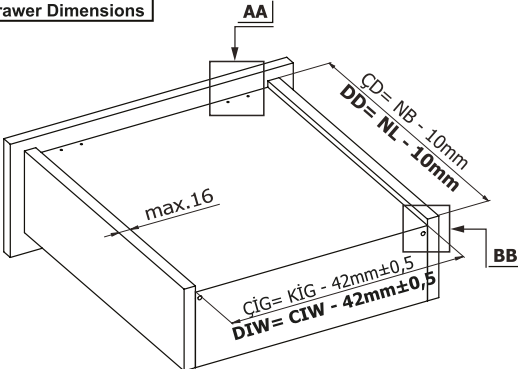

Kabin Ölçüleri
Cabinet Dimensions

Kabin İç Geniřliđi	: KİG	Cabinet Internal Width	: CIW
Kabin İç Derinliđi	: KİD	Cabinet Internal Depth	: CID
Çekmece Derinliđi	: ÇD	Drawer Depth	: DD
Çekmece İç Geniřliđi	: ÇİG	Drawer Internal Width	: DIW
Nominal Boy (Ray boyu): NB		Nominal Length	: NL

Tavsiye Edilen Vida ve Şablonlar
Recommended Screw and TemplatesRayların Vida Konum Ölçüleri
Screw Location for the Slides

Rayı, koyu renk ile işaretlenmiş deliklerden vidalayınız.
Screw the slide from marked holes.

Çekmece Ölçüleri
Drawer Dimensions

1

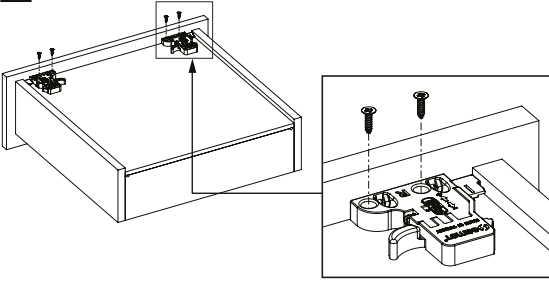

Not: Çekmece taban kalınlığı 12 mm'den küçük olduğunda, açılı mandal bağlama deliklerini kullanınız.

Note: Use angled holes to mount smart lock when wooden floor width is selected less than 12 mm.

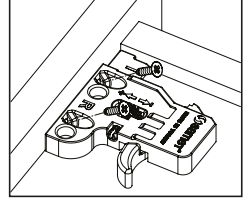
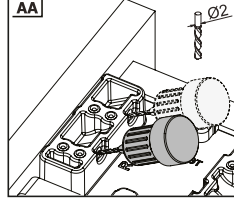

2

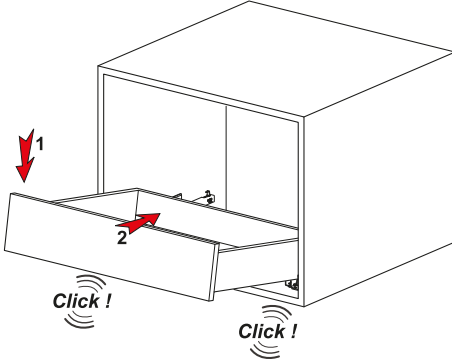

3

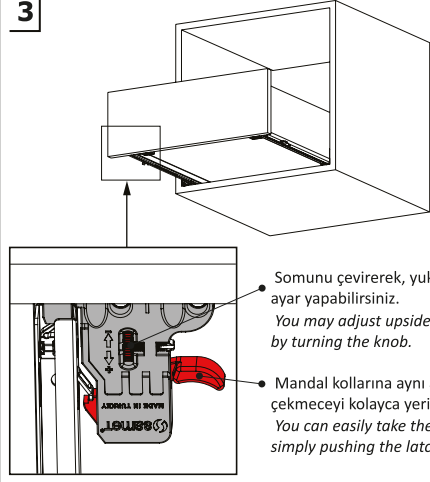

Somunu çevirerek, yukarıya doğru ayar yapabilirsiniz.
You may adjust upside positioning by turning the knob.

Mandal kollarına aynı anda basarak, çekmeceyi kolayca yerinden çıkarabilirsiniz.
You can easily take the drawer out by simply pushing the latch smart lock

Smart El Tipi Ray
Montaj Şablonu
Smart Drilling Jig

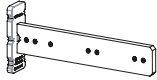

Kod / Code

12799902

12799904

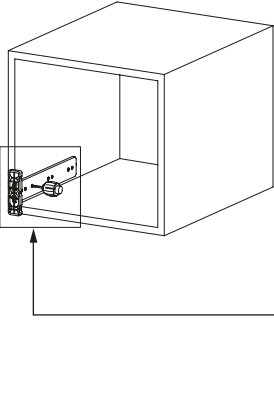

Smart Cetveli Ray
Montaj Şablonu
Smart Drilling Jig with Ruler

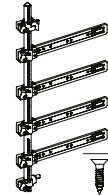

Kod / Code

12799901

12799905

